

LEGEND	
	- 1/4" QUICK CONNECT
	- 1/4" QUICK CONNECT PIGGYBACK
	- FORK CONNECTOR
	- RING CONNECTOR
	- SOCKET CONNECTOR
	- PIN CONNECTOR

Light Receptacle

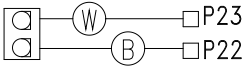

SYSTEM FUSE
RED

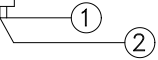

PUMP 1 FUSE
RED

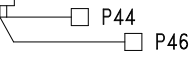

AUXILIARY FUSE
RED

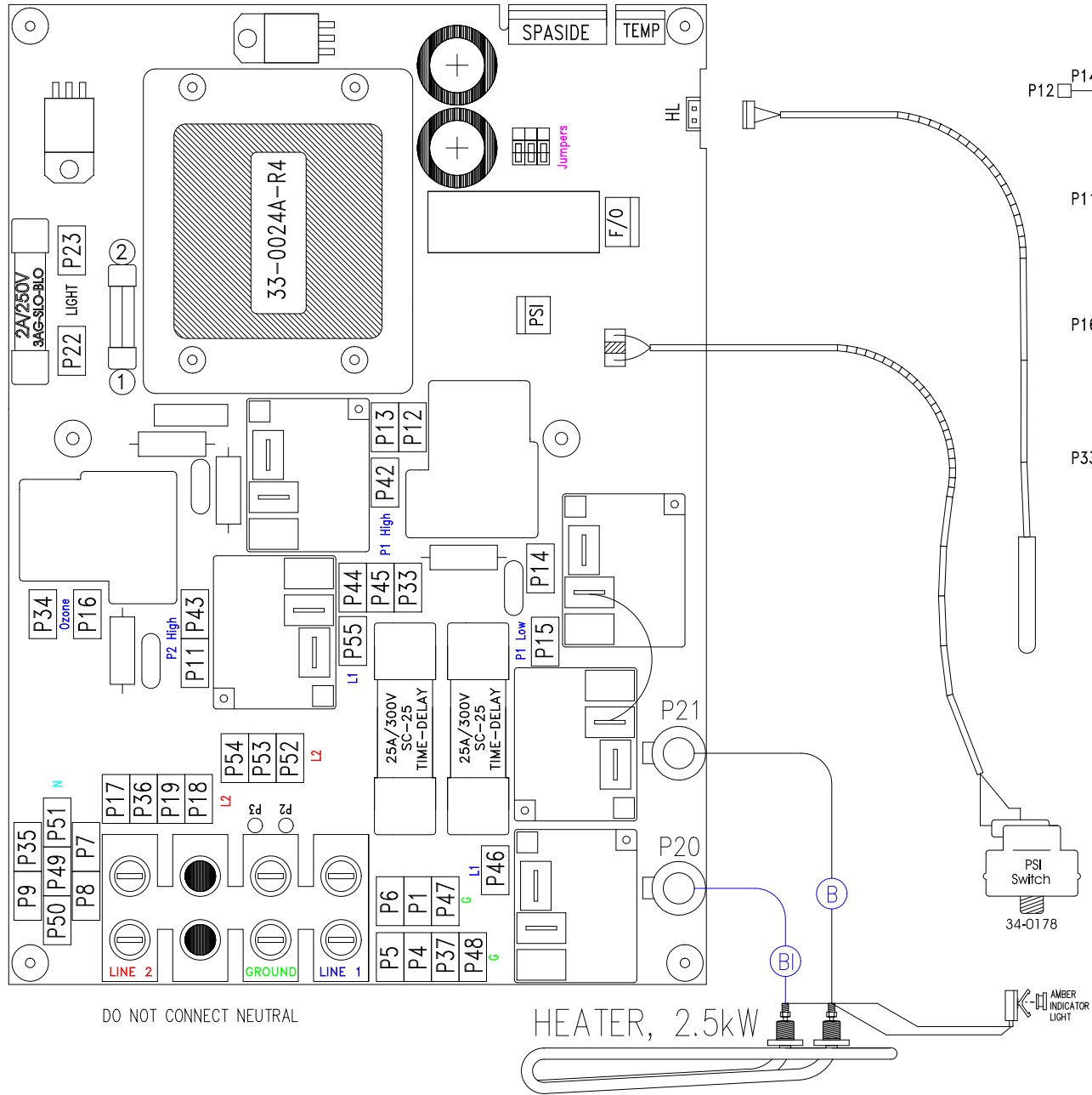
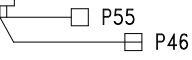

DO NOT CONNECT NEUTRAL

HEATER, 2.5kW

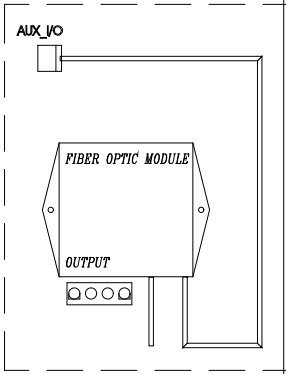
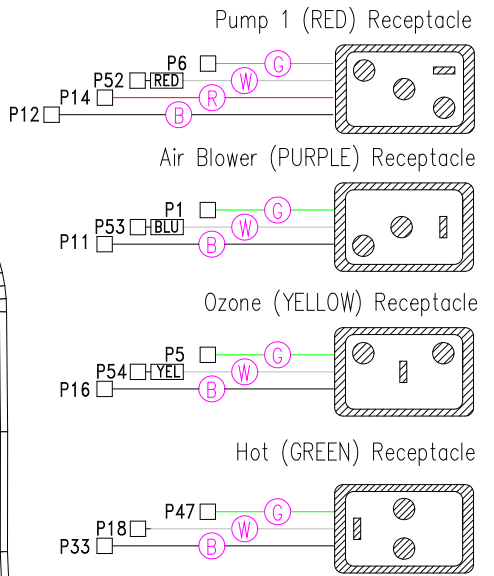

HYDRO-QUIP
CORONA, CA (909) 273-7575

Manufacture Notes:

Dwg. No.
J202A0-KQY69-BZ
Sheet metal part #:
65-0189

Drawn
BH
Date
03.31.04
Diagram No.
4902-J

Wire Color Code	
B - Black	G - Green
Br - Brown	Bl - Blue
R - Red	V - Violet
O - Orange	W - White
Y - Yellow	Gr - Gray